



CRICUT®
EVERYDAY



Our everyday cartridge
for any project

Tags, Bags, Boxes & More® 2



The NEW Cricut® design program!

- Access online from anywhere, anytime
- Intuitive, easy-to-use program
- Design on a big screen
- View and design with the complete Cricut® cartridge library
- Search to easily find the right image
- Save your projects
- Share and collaborate on projects
- Windows and Mac compatible
- Free!



Try it out at
www.Cricut.com/craftroom

Le NOUVEAU programme de design Cricut®!

- Accédez-y en ligne, à tout moment et où que vous soyez
- Programme facile à utiliser et d'approche intuitive
- Créez vos designs sur un grand écran
- Visualisez et faites vos designs en utilisant la bibliothèque complète de cartouches Cricut®
- Recherchez pour trouver facilement l'image appropriée
- Sauvegardez vos projets
- Partagez-vous vos projets et associez-vous aux autres créateurs
- Compatible avec Windows et Mac
- Gratuit!



Essayez-le sur
www.Cricut.com/craftroom

¡El NUEVO programa de diseño de Cricut®!

- Acceda en línea desde cualquier parte y en cualquier momento
- Programa fácil de utilizar y de operación intuitiva
- Realice sus diseños en una gran pantalla
- Visualice y diseñe con la biblioteca completa de cartuchos Cricut®
- Realice búsquedas para encontrar fácilmente la imagen apropiada
- Guarde sus proyectos
- Comparta sus proyectos y colabore con otros creadores
- Compatible con Windows y con Mac
- ¡Gratis!



Compruébelo visitando
www.Cricut.com/craftroom

Das **NEUE** Cricut® Designprogramm!

- Onlinezugriff überall und jederzeit
- Intuitives Programm mit einfacher Handhabung
- Entwerfen Sie auf einem großen Bildschirm
- Gestalten Sie mit der gesamten Cricut®-Kassettenbibliothek.
- Suchfunktion zum einfachen Finden des richtigen Bildes
- Speichern Sie Ihre Projekte
- Austausch und Zusammenarbeit an Projekten
- Kompatibel mit Windows und Mac
- **Gratis!**



Testen Sie jetzt auf
www.Cricut.com/craftroom

Contents • Table des Matières • Indice • Inhalt

English

What is Real Dial Size?	7
Quick Start Project.....	9
Icon Gallery.....	19
Contact Us	80

Español

¿Qué hace el Real Dial Size?	8
Proyecto de Iniciación Rápida	13
Galería de Iconos.....	21
Contáctenos	81

Français

Qu'est-ce qui le Real Dial Size fait?	7
Projet de Commencement Rapide.....	11
Galerie d'icônes	20
Contactez-nous	80

Deutsch

Was ist Real Dial Size?	8
Schnellstartprojek	15
Bildergalerie.....	22
Verbinden Sie sich mit uns.....	81

For complete instructions
see your Cricut® user manual
or visit www.cricut.com

Pour des instructions complètes
veuillez vous référer au Manuel
de l'Utilisateur Cricut® ou visiter
le site www.cricut.com

Para instrucciones detalladas
refiérase a su Manual del
Usuario Cricut® o visite
la página www.cricut.com

Finden Sie vollständige
Anweisungen in Ihrem Cricut®
Benutzerhandbuch oder
besuchen Sie www.cricut.com

What is Real Dial Size? • Qu'est-ce qui le Real Dial Size fait?



All characters are measured from the lowest possible point to the highest. In Tags, Bags, Boxes & More[®] 2, the non-shift base images, **Box Section** features, **Tag** feature, and **Phrase** features are all created at the same height. The **Card Phrase** images will cut out in proportion to the **Card** feature. If **Real Dial Size** is selected, all characters will be cut according to the size specified.

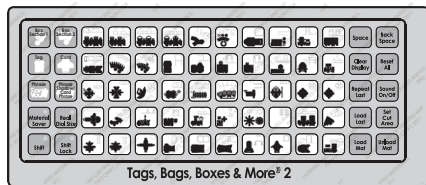

Tous les caractères sont mesurés à partir du point le plus bas possible jusqu'au point le plus haut. Dans la cartouche Tags, Bags, Boxes & More[®] 2, les images de base avec la touche **Shift** non activée, ainsi que celles des fonctions **Box Section** (Section Boîte), **Tag** (Etiquette) et **Phrase** sont toutes créées de la même hauteur. Les images de la fonction **Card Phrase** (Phrase de Carte) seront coupées proportionnellement aux images de la fonction **Card** (Carte). Si vous avez sélectionné le **Real Dial Size** (Disque de Définition de la Taille Réelle), tous les caractères seront coupés en accord avec la taille spécifiée.

¿Qué hace el Real Dial Size? • Was ist Real Dial Size?



Real Dial Size OFF
(Desactivé)



Real Dial Size ON
(Activé)

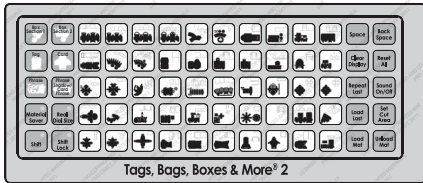

Todos los caracteres se miden desde el punto más bajo posible al punto más alto. En el cartucho Tags, Bags, Boxes & More® 2, las imágenes base con la tecla **Shift** no activada y las de las funciones **Box Section** (Sección de Caja), **Tag** (Etiqueta) y **Phrase** (Frase), son todas creadas de la misma altura. Las imágenes de la función **Card Phrase** (Frase de Tarjeta) serán cortadas en proporción a las de la función **Card** (Tarjeta). Si se selecciona el **Real Dial Size** (Disco de Definición de Tamaño Real), todos los caracteres se cortarán de acuerdo con el tamaño especificado.

Alle Zeichen werden vom untersten möglichen Punkt bis zum höchsten möglichen Punkt gemessen. In Tags, Bags, Boxes & More® 2 werden die Nicht-**Shift**-Grundbilder, die Funktionen von **Box Section** (Schachtelteil), die Funktion **Tag** (Etikett) und die Funktionen von **Phrase** (Satz) alle auf der gleichen Höhe erstellt. Die Bilder von **Card Phrase** (Karte Satz) werden proportional zu der Funktion **Card** (Karte) ausgestanzt. Ist **Real Dial Size** (Realgrößenwähler) gedrückt, werden alle Zeichen entsprechend der angegebenen Größe ausgestanzt.

Now you're ready to try a project!



For You Card

This cute card is quick and easy to make!

Materials:

- Cricut® Gel Pens, Black
- Cricut® Scoring Tip
- Cardstock: green, black, white
- Adhesive



Step One:

Create score lines. Place scoring tip in the machine. Using green cardstock, select **Card** feature, press **Shift**, and score one 4 ½" <CndyBx-s>. Press **Load Mat**.



Step Two:

Create *For You* sentiment. Place gel pen in the machine. Select the **Phrase Shadow/Card Phrase** feature, press **Shift**, and draw one 4 ½" <CpckB1-s>. Press **Load Mat**.



Step Three:

Cut card. Select the **Card** feature and cut one 4 ½" <CandyBx>. Remove from mat and fold in half. Cut one 4 ½" x 2" block of black cardstock. Fold in half. Adhere block inside card and behind the holes.

Maintenant vous êtes prêt à vous lancer dans un projet!



Carte For You (Pour Vous)

Cette carte mignonne est si rapide et facile à faire!

Matériaux:

- Stylos à encre gel Cricut®, noir
- Pointe pour rainage Cricut®
- Papier Cartonné: vert, noir, blanc
- Colle



Étape Un:

Pour créer les lignes rainurées. Placez la pointe pour rainage dans la machine. En utilisant du papier cartonné vert, sélectionnez la fonction **Card** (Carte), pressez **Shift** et rainurez un <CndyBx-s> de 4 ½" (11.5 cm). Pressez la touche **Load Mat** (Charger le Tapis).



Étape Deux:

Pour créer l'ornement *For You* (Pour Vous). Placez le stylo à encre gel dans la machine. Sélectionnez la fonction **Phrase Shadow/ Card Phrase** (Ombrage de Phrase / Phrase de Carte), pressez **Shift** et dessinez un <CpckB1-s> de 4 ½" (11.5 cm). Pressez la touche **Load Mat** (Charger le Tapis).



Étape Trois:

Pour couper la carte. Sélectionnez la fonction **Card** (Carte) et coupez un <CandyBx> de 4 ½" (11.5 cm). Enlevez-la du tapis et pliez-la en deux. Coupez une pièce de papier cartonné noir de 4 ½" x 2" (11.5 cm x 5.5 cm). Pliez-la en deux. Collez la pièce à l'intérieur de la carte et derrière les trous.

¡Ahora está preparado para intentar realizar un proyecto!



For You Card (Tarjeta Para Ti)

¡Esta tierna tarjeta es tan rápida y fácil de hacer!

Materiales:

- Lápices de Gel Cricut®, Negro
- Punta para Marcar Cricut®
- Papel Cardstock: verde, negro, blanco
- Pegamento



Paso Uno:

Para crear las líneas marcadas. Ponga la punta para marcar en la máquina. Utilizando papel cardstock color verde, seleccione la función **Card** (Tarjeta), presione **Shift** y marque un <CndyBx-s> de 4 ½" (11.5 cm). Presione **Load Mat** (Cargar Almohadilla).



Paso Dos:

Para crear el adorno *For You* (Para Ti). Ponga el lápiz de gel en la máquina. Seleccione la función **Phrase Shadow/Card Phrase** (Sombreado de Frase / Frase de Tarjeta), presione **Shift** y dibuje un <CpckB1-s> de 4 ½" (11.5 cm). Presione **Load Mat** (Cargar Almohadilla).



Paso Tres:

Para cortar la tarjeta. Seleccione la función **Card** (Tarjeta) y corte un <CandyBx> de 4 ½" (11.5 cm). Retírela de la almohadilla y dóblela por la mitad. Corte un trozo de papel cardstock color negro de 4 ½" x 2" (11.45 cm x 5.5 cm). Dóblelo por la mitad. Pegue el trozo dentro de la tarjeta y por detrás de los orificios.

Sie sind nun bereit, ein Projekt auszuprobieren!



Karte „For You“ (Für Dich)

Diese süße Karte ist schnell und einfach nachzumachen!

Materialien:

- Cricut® Gelstift, schwarz
- Cricut® Ritzmesser
- Kartonpapier: grün, schwarz, weiß
- Klebstoff



Erster Schritt:

Für die Einkerbungen: Führen Sie das Ritzmesser ins Gerät ein, wählen Sie die Funktion **Card** (Karte) aus, drücken Sie die **Shift**-Taste und erstellen Sie eine 4 ½" (11.5 cm) große Einkerbung <CndyBx-s>. Drücken Sie die Taste **Load Mat** (Unterlage einziehen).



Zweiter Schritt:

Für den Schriftzug *For You*: Führen Sie den Gelstift ins Gerät ein, wählen Sie die Funktion **Phrase Shadow/Card Phrase** (Satz Schatten/Karte Satz) aus, drücken Sie die **Shift**-Taste und zeichnen Sie ein 4 ½" (11.5 cm) großes <CpckB1-s>. Drücken Sie die Taste **Load Mat** (Unterlage einziehen).



Dritter Schritt:

Für die Karte: Wählen Sie die Funktion **Card** (Karte) aus und schneiden Sie ein 4 ½" (11.5 cm) großes <CandyBx> aus. Entfernen Sie die Karte von der Unterlage und falten Sie sie in der Mitte zusammen. Schneiden Sie ein 4 ½" x 2" (11.5 cm x 5.5 cm) großes Rechteck aus schwarzem Karton aus und falten Sie es in der Mitte zusammen. Kleben Sie das Rechteck in die Karte hinter die Löcher.

The Tags, Bags, Boxes & More® 2 cartridge was designed to work with the Cricut® scoring tip (2001330) and Cricut® gel pens (2001319). The scoring tip helps you get clean, crisp folds on your cards, tags, bags, and boxes. The gel pens are designed to draw anything you can cut. They are specially designed for the **Card Phrase** feature on this cartridge. (See page 19 for which images go with which tool.)

The scoring tip and gel pens are sold separately. Visit www.cricut.com/score for instructions on how to use the scoring tip and www.cricut.com/gelpens for instructions on how to use the gel pens.

32 Go to this page in the assembly instructions booklet to see how to create this project.



La cartouche Tags, Bags, Boxes & More® 2 a été conçue pour travailler avec la pointe pour rainage (2001330) Cricut® et avec les stylos à encre gel (2001319) Cricut®. Les pointes pour rainage vous aident à obtenir des plis nets et précis dans vos cartes, étiquettes, sacs et boîtes. Les stylos à encre gel ont été conçus pour dessiner tout ce que vous pouvez couper. Ils ont été conçus spécialement pour être utilisés avec la fonction **Card Phrase** (Phrase de Carte) dans cette cartouche. (Veuillez vous référer à la page 20 pour savoir quelles images vont avec quel outil.)

La pointe pour rainage et les stylos à encre gel sont vendus séparément. Visitez www.cricut.com/score pour obtenir des instructions sur la façon d'utiliser la pointe pour rainage et www.cricut.com/gelpens pour des instructions sur la façon d'utiliser les stylos à encre gel.

32 Allez à cette page sur la guide d'instructions de montage pour savoir comment créer ce projet.

El cartucho Tags, Bags, Boxes & More® 2 fue diseñado para trabajar con la punta para marcar de Cricut® (2001330) y los lápices de gel Cricut® (2001319). La punta para marcar le ayudará a obtener pliegues precisos y bien definidos en sus tarjetas, etiquetas, bolsos y cajas. Los lápices de gel se han diseñado para dibujar cualquier cosa que usted pueda cortar. Se han diseñado especialmente para ser utilizados con la función **Card Phrase** (Frase de Tarjeta) de este cartucho. (Referirse a la página 21 para ver que imágenes van con qué herramienta.)

La punta para marcar y los lápices de gel se venden por separado. Visite www.cricut.com/score para obtener instrucciones sobre cómo utilizar la punta para marcar y www.cricut.com/gelpens para instrucciones sobre cómo utilizar los lápices de gel.

32 Diríjase a esta página del cuadernillo de instrucciones de ensamblaje para ver cómo crear este proyecto.



Die Kasette Tags, Bags, Boxes & More® 2 wurde für die Nutzung mit dem Cricut® Ritzmesser (2001330) und den Cricut® Gelstiften (2001319) entworfen. Das Ritzmesser ermöglicht Ihnen saubere, scharfe Knickkanten für Ihre Karten, Etiketten, Tüten und Schachteln. Die Gelstifte wurden zum Zeichnen von beliebigen Ausstanzformen entworfen und sind speziell für die Funktion **Card Phrase** (Karte Satz) auf dieser Kasette gedacht. (Auf Seite 22 wird genauer beschreiben, welche Bilder sich für das jeweilige Werkzeug eignen.)

Ritzmesser und Gelstifte sind separat im Handel erhältlich. Unter www.cricut.com/score finden Sie eine Anleitung zum Gebrauch des Ritzmessers und unter www.cricut.com/gelpens eine Anleitung zum Gebrauch der Gelstifte.

32 Auf dieser Seite in der Anleitung zum Zusammensetzen finden Sie Information zur Erstellung dieses Projekts.

In the Icon Gallery you will find a diagram for every image on your cartridge. The images in the circled areas are created using the **Shift** key. You can see at a glance what Creative Features are available for the image you have selected in the Icon Gallery. **Some shapes are very intricate and will cut best at larger sizes.**

 Use Scoring Tool

 Use Gel Pen

Tags, Bags, Boxes & More® 2

Creative Features:

- **Box Section 1**
- **Box Section 2**
- **Tag**
- **Card**
- **Phrase**
- **Phrase Shadow/Card Phrase**

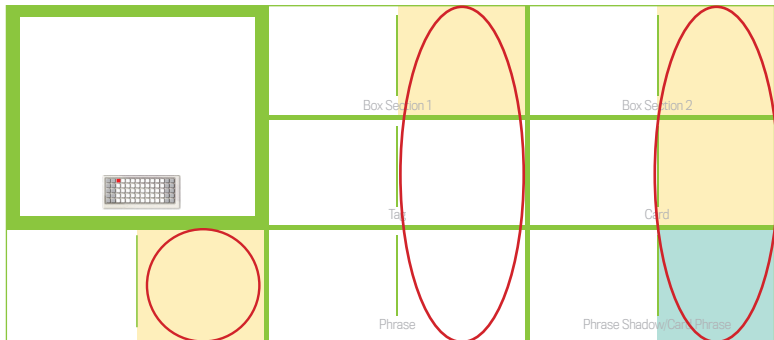

Dans la Galerie d'Icônes vous trouverez un diagramme pour chaque image de votre cartouche. Les images dans des zones encadrées sont créées en utilisant la touche **Shift**. Vous pouvez voir d'un coup d'œil quelles des Fonctions Créatives sont disponibles pour l'image que vous avez sélectionné dans la Galerie d'Icônes. **Quelques formes sont très élaborées et il vaudrait mieux les couper en des tailles plus grandes.**

 Employez l'Outil de Rainage

 Employez le Stylo à Encre Gel

Fonctions Créatives de la Cartouche Tags, Bags, Boxes & More® 2 :

- **Box Section 1** (Section Boîte 1)
- **Box Section 2** (Section Boîte 2)
- **Tag** (Etiquette)
- **Card** (Carte)
- **Phrase**
- **Phrase Shadow/Card Phrase** (Ombrage de Phrase / Phrase de Carte)

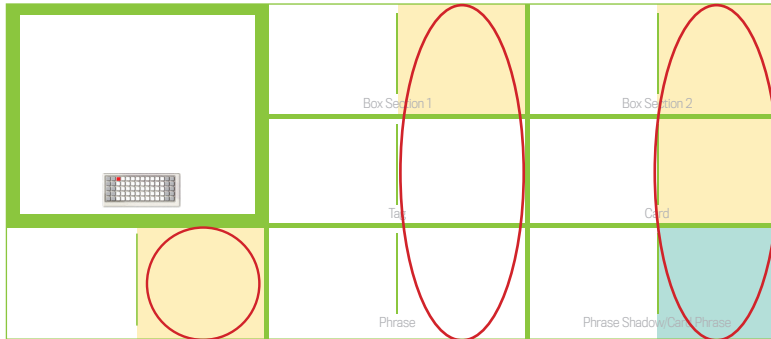

En la Galería de Iconos encontrará un diagrama para cada imagen de su cartucho. Las imágenes en las áreas rodeadas con un círculo son creadas utilizando la tecla **Shift**. Podrá ver de inmediato qué Funciones Creativas están disponibles para la imagen que ha seleccionado en la Galería de Iconos. **Algunas formas son muy elaboradas y se cortarán mejor en tamaños más grandes.**

 Use la Herramienta para Rayado

 Use el Lápiz de Gel

Tags, Bags, Boxes & More® 2
Funciones Creativas:

- **Box Section 1** (Sección de Caja 1)
- **Box Section 2** (Sección de Caja 2)
- **Tag** (Etiqueta)
- **Card** (Tarjeta)
- **Phrase** (Frase)
- **Phrase Shadow/Card Phrase** (Sombreado de Frase / Frase de Tarjeta)

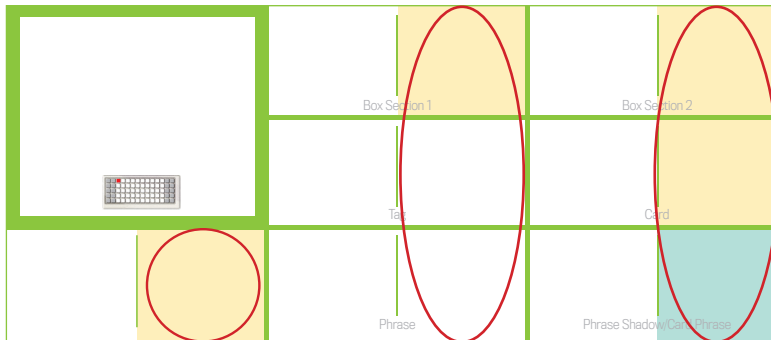

In der Symbolgalerie finden Sie ein Diagramm für jedes Bild auf Ihrer Kassette. Die Bilder in den eingekreisten Bereichen werden mit der **Shift**-Taste erstellt. Sie sehen auf einen Blick, welche Kreativfunktionen für das ausgewählte Bild aus der Symbolgalerie zur Verfügung stehen. **Einige Figuren sind sehr detailreich und werden am besten in größeren Dimensionen ausgestanzt.**

 Benutzen Sie das Ritzwerkzeug.

 Benutzen Sie den Gelstift

Tags, Bags, Boxes & More® 2
Creative Features:

- **Box Section 1** (Schachtelteil 1)
- **Box Section 2** (Schachtelteil 2)
- **Tag** (Etikett)
- **Card** (Karte)
- **Phrase** (Satz)
- **Phrase Shadow/Card Phrase** (Satz Schatten/
Karte Satz)

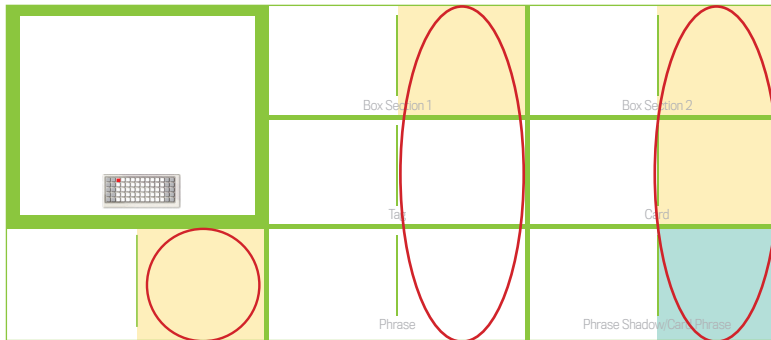

Some of the images on this cartridge are very intricate and will cut best at certain sizes. These images have an icon next to them in the icon gallery.
Certaines des images dans cette cartouche sont très élaborées et les résultats seront meilleurs si elles sont coupées en des tailles spécifiques. Ces images vont avoir un icône à leur côté dans la galerie d'icônes.

Algunas de las imágenes de este cartucho son muy elaboradas y se cortarán mejor en ciertos tamaños. Estas imágenes tendrán un ícono representado a su lado en la galería de íconos.

Einige der Bilder auf dieser Kassette sind sehr aufwendig und lassen sich am besten in bestimmten Größen ausschneiden. Diese Bilder sind durch ein Symbol gekennzeichnet, das neben ihnen in der Symbolgalerie erscheint.

 Image should be cut at this size or larger.
L'image devrait être coupée de cette taille ou plus grande.
La imagen debe ser cortada de este tamaño o más grande.
Das Bild sollte in dieser Größe oder größer ausgeschnitten werden.

 Image should be cut at this size or larger with the **Fit to Length** function* activated.
L'image devrait être coupée de cette taille ou plus grande avec la fonction* **Fit to Length** (Ajuster à la Longueur) activée.
La imagen debe ser cortada de este tamaño o más grande con la función* **Fit to Length** (Ajustar al Largo) activada.
Das Bild sollte in dieser Größe oder größer sowie mit der aktivierten Funktion **Fit to Length** (Längenanpassung)* ausgeschnitten werden.

*Not all machines have this function. Please see your machine user manual for details.

*Cette fonction n'est pas dans toutes les machines. Veuillez consulter le manuel de l'utilisateur de votre machine pour plus d'information.

*No todas las máquinas tienen esta función. Le rogamos consultar el manual de usuario de su máquina para mayor información.

*Nicht alle Geräte verfügen über diese Funktion. Genauere Information finden Sie im Benutzerhandbuch Ihres Geräts.

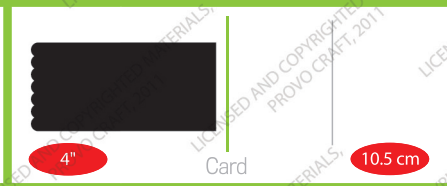
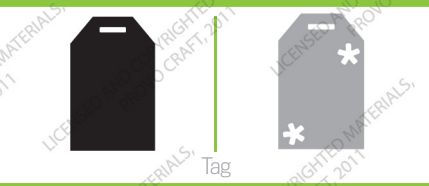
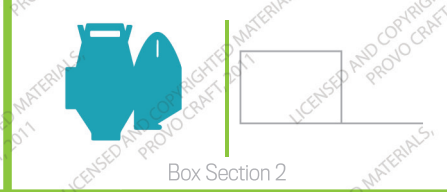
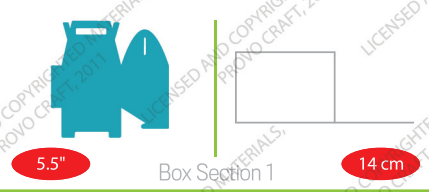

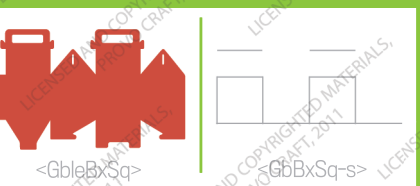
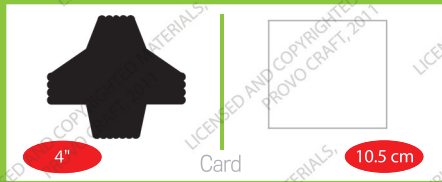
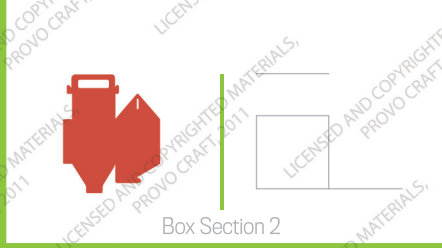
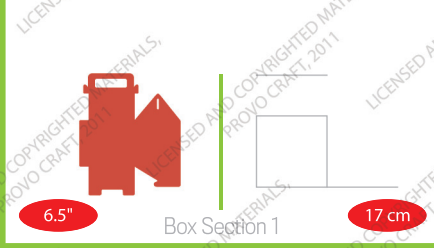

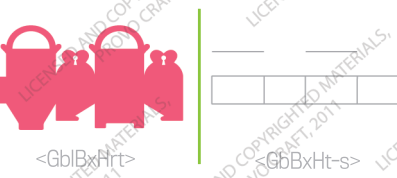
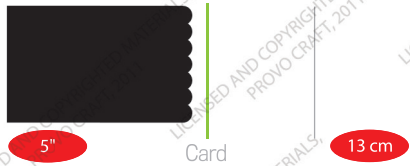
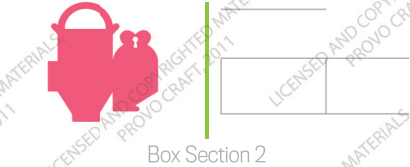
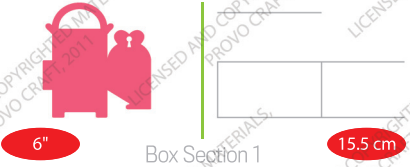

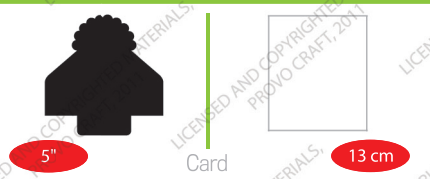
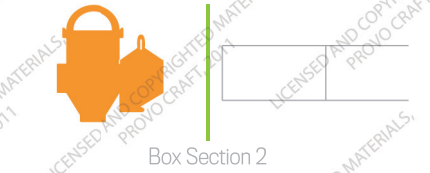
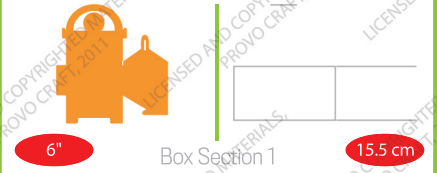

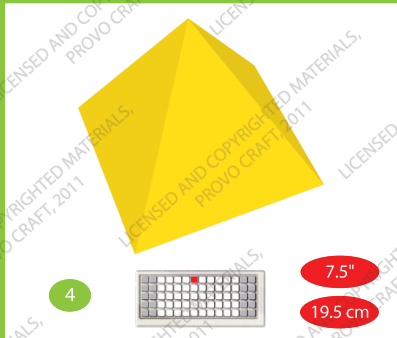

6"

Box Section 1



15.5 cm



Box Section 2



Tag



5"

Card

13 cm



<TeaPyrd>



<TePyrd-s>



Phrase



Phrase Shadow/Card Phrase





Box Section 1



Box Section 2

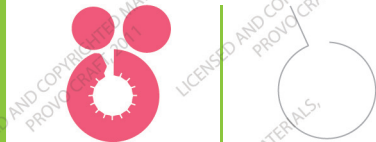

Tag



Card



<Teacups>



<Teacup-s>



Phrase



Phrase Shadow/Card Phrase



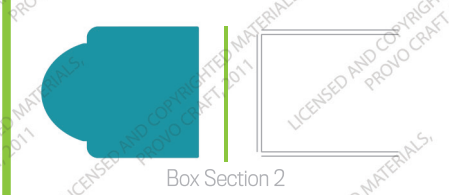
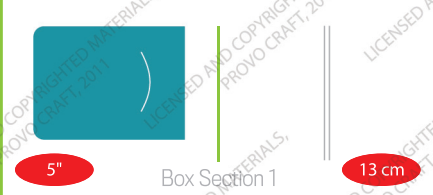

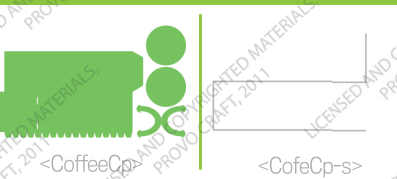
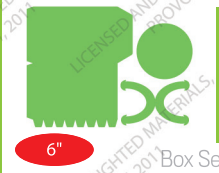

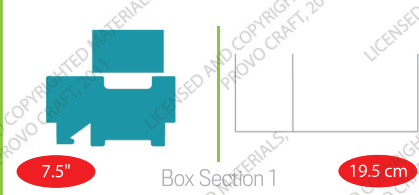

Box Section 1

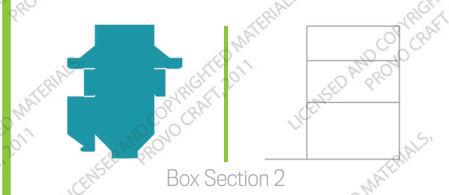

Box Section 2

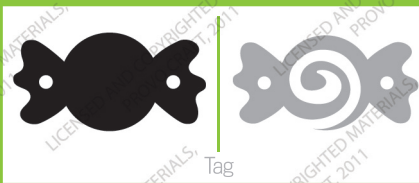

Tag



Card

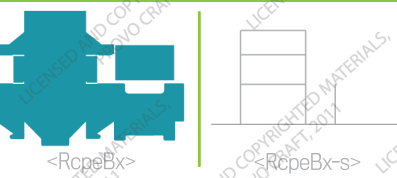

<RcpeBx>

<RcpeBx-s>



Phrase



Phrase Shadow/Card Phrase

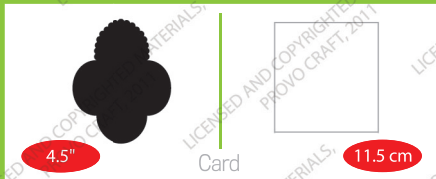
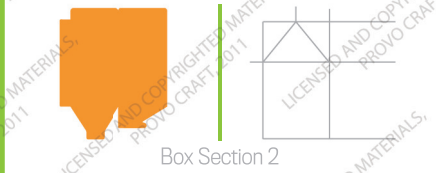
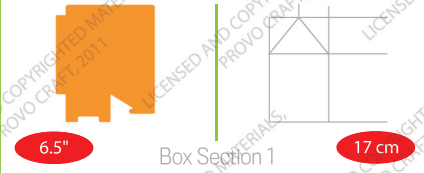
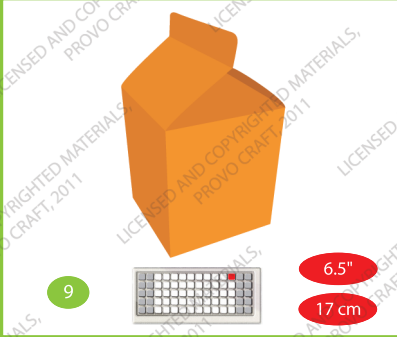

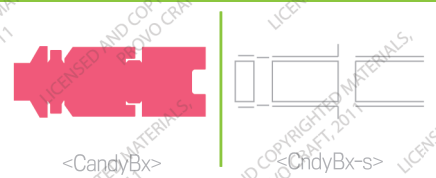
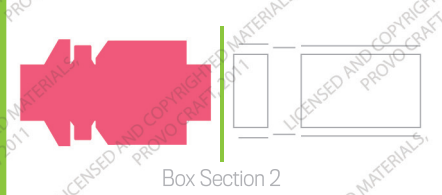
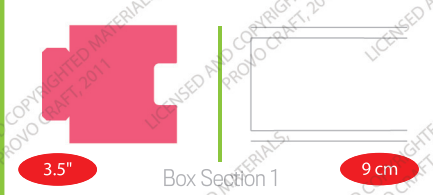

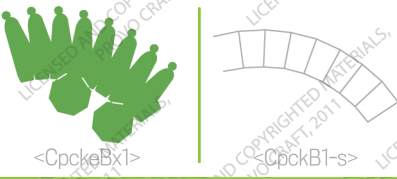
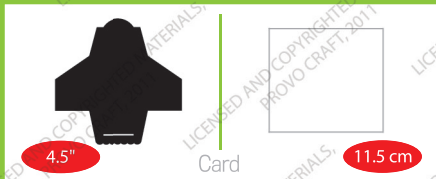
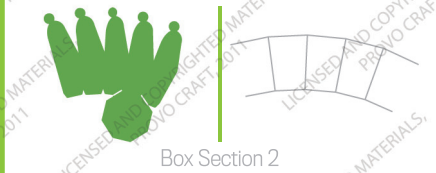
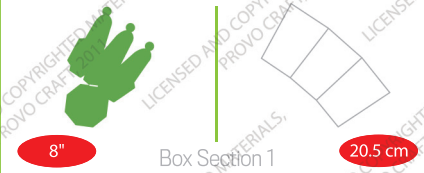

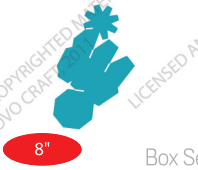

Box Section 1



Box Section 2

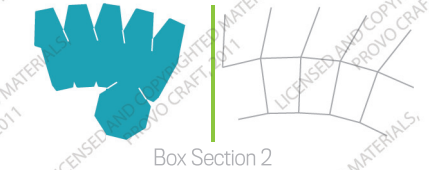

Tag



Card

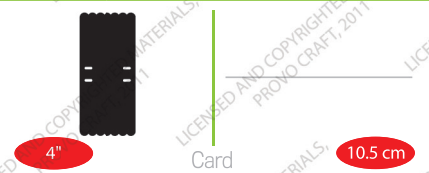

Phrase



Phrase Shadow/Card Phrase



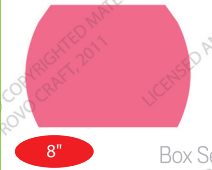
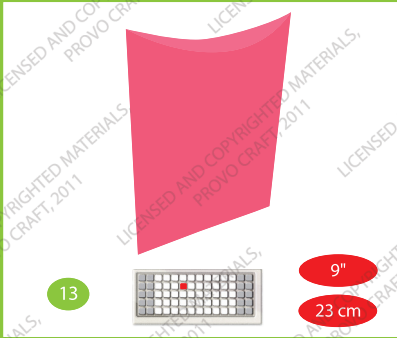

Box Section 1

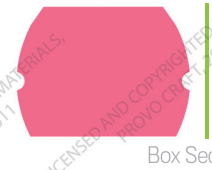

Box Section 2



Tag

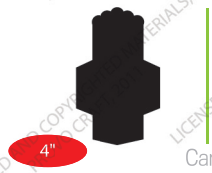

Card

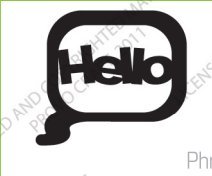

Phrase



Phrase Shadow/Card Phrase



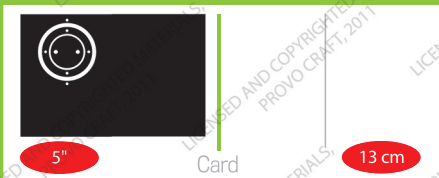
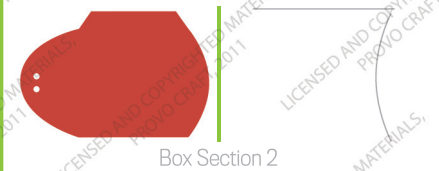
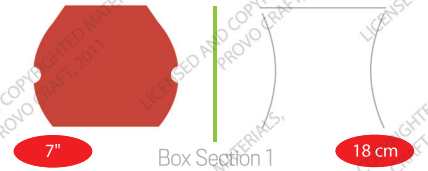
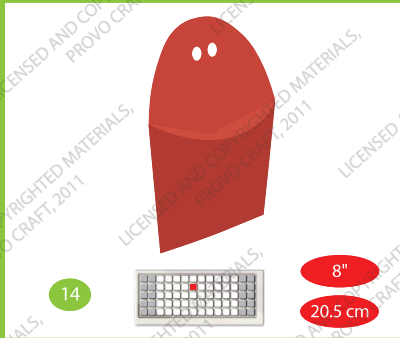



5.5"

Box Section 1



14 cm



Box Section 2



Tag



5"

Card



13 cm



<TreatBag>

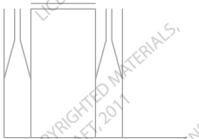

<TrtBag-s>



Phrase



Phrase Shadow/Card Phrase



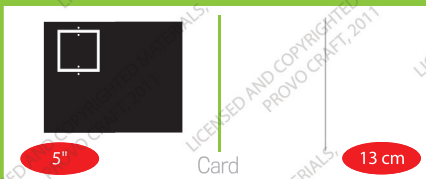
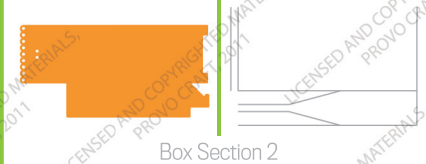

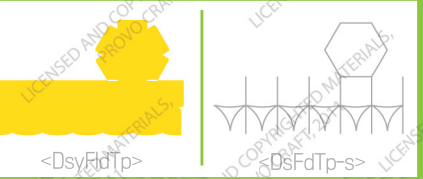
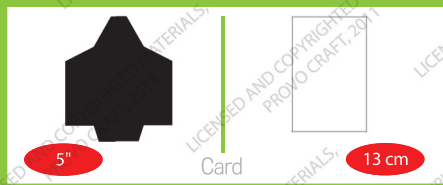
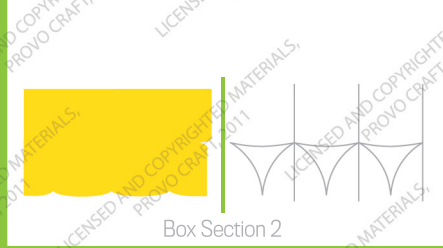
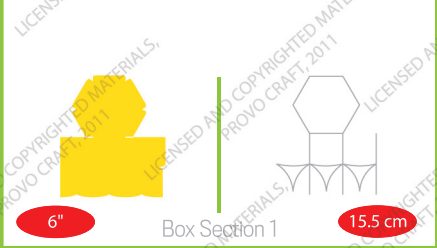

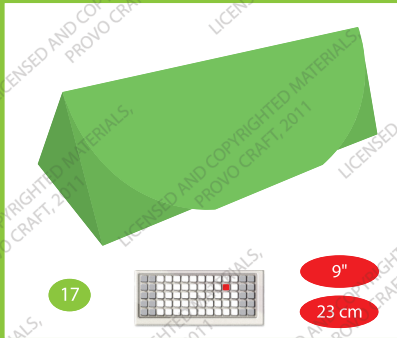

5.5"

Box Section 1



14 cm



Box Section 2



Tag



5"

Card



13 cm



<LpstckBx>



<LpskBx-s>



Phrase



Phrase Shadow/Card Phrase



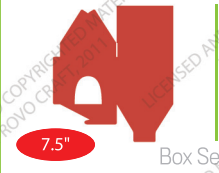
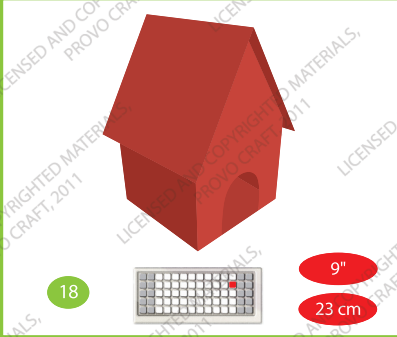

Box Section 1

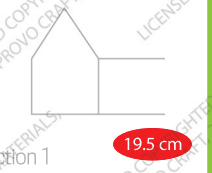

19.5 cm



Box Section 2



Tag



5"

Card



13 cm



<Doghouse>



<Doghse-s>



Phrase



Phrase Shadow/Card Phrase



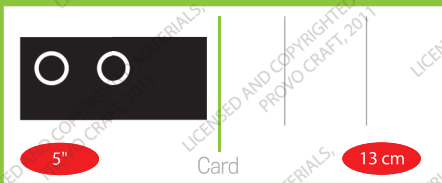
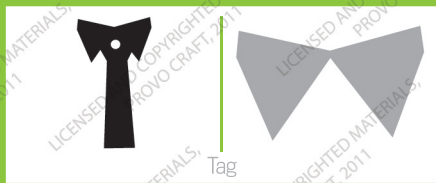
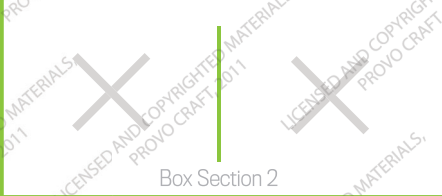
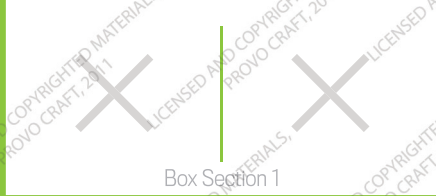



19

9"
23 cm

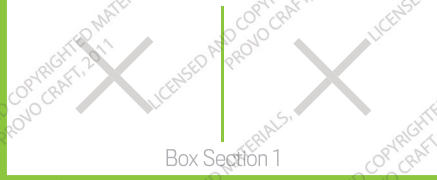

Box Section 1

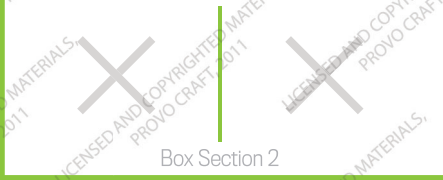

Box Section 2



Tag



5"

Card



13 cm



<OnesieBx>

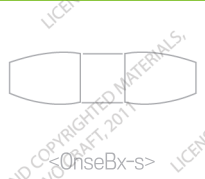

<OnseBx-s>



Phrase



Phrase Shadow/Card Phrase



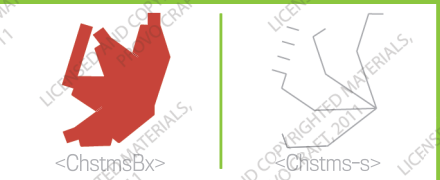
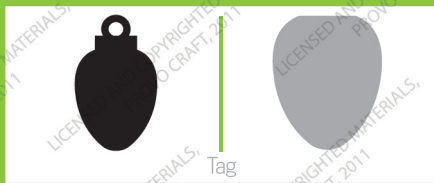
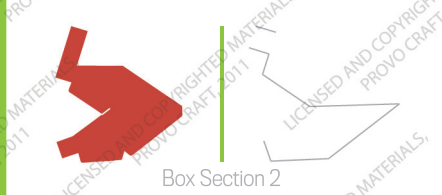
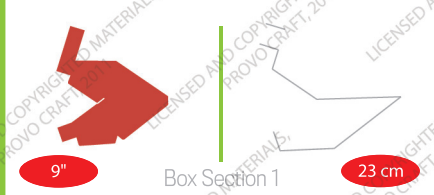
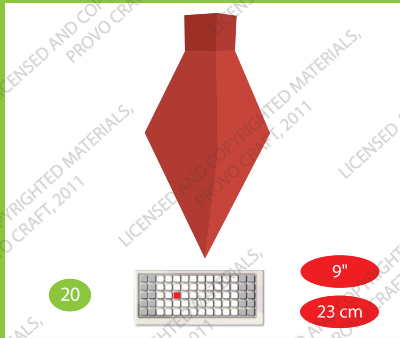

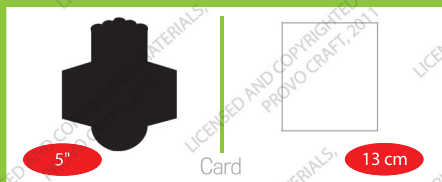
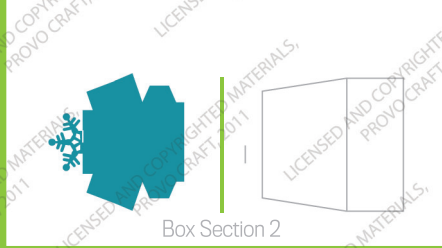
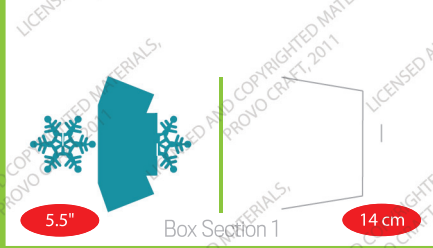

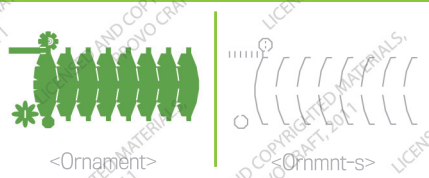
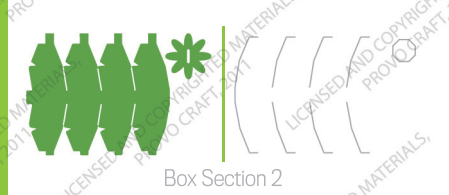
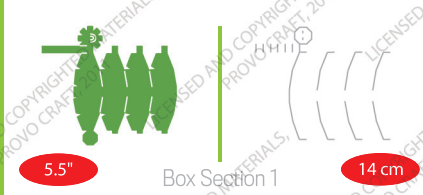
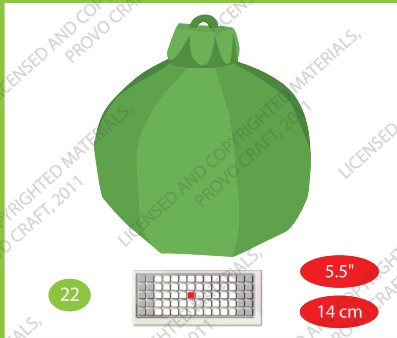



23

5"
13 cm

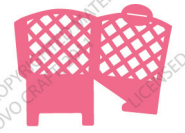

5"

Box Section 1



13 cm



Box Section 2



Tag



5"

Card



13 cm



<EstrBskt>



<EtrBkt-s>



Phrase



Phrase Shadow/Card Phrase



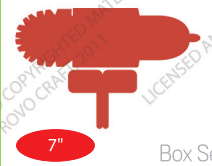
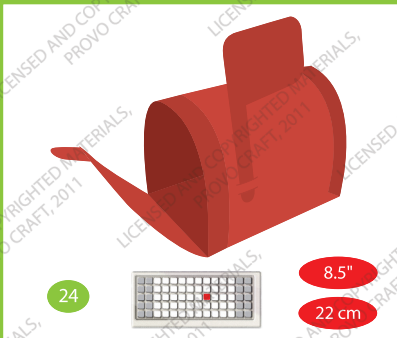

Box Section 1

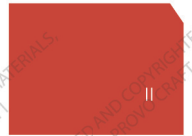
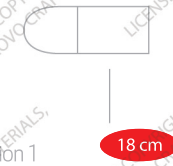

Box Section 2



Tag

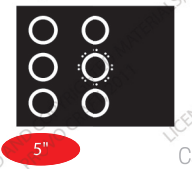

Card



<VtnMlbx>

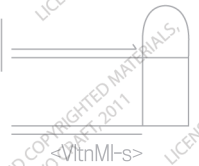

<VtnMI-s>



Phrase



Phrase Shadow/Card Phrase



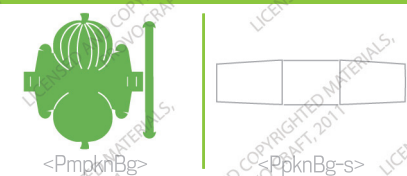
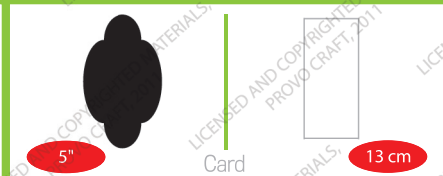
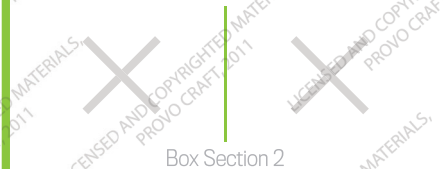
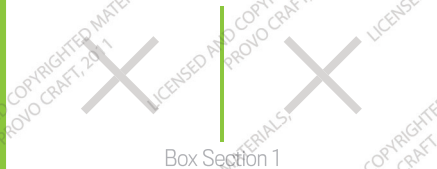

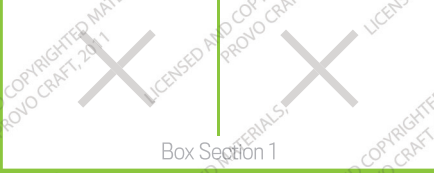
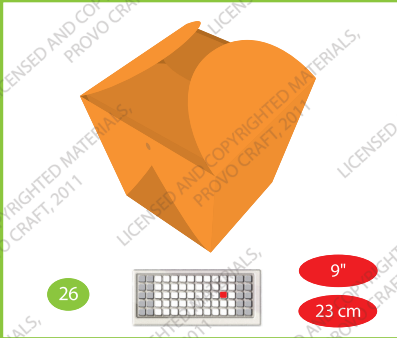

Box Section 1



Box Section 2



Tag



Card

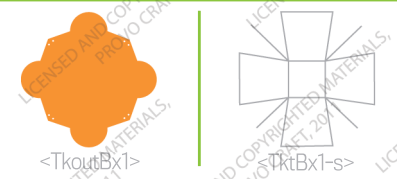

<TkoutBx1>

<TktBx1-s>



Phrase



Phrase Shadow/Card Phrase

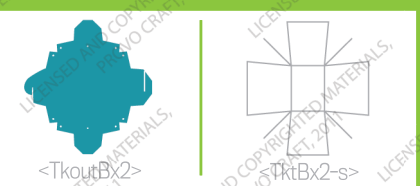
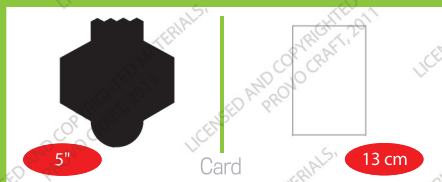
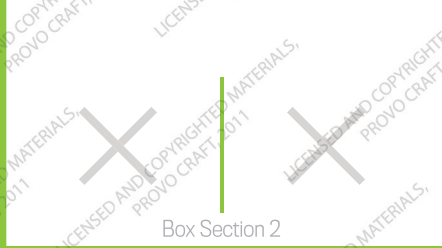
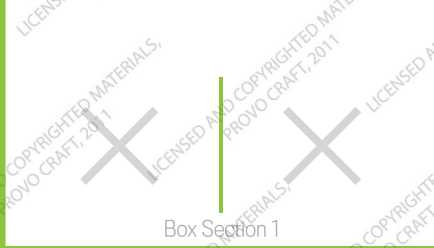
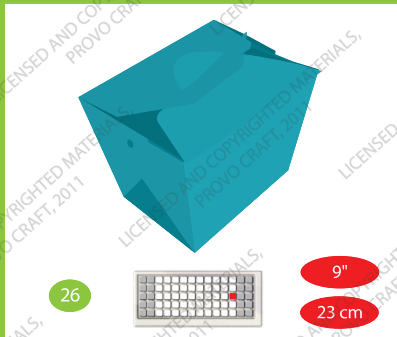

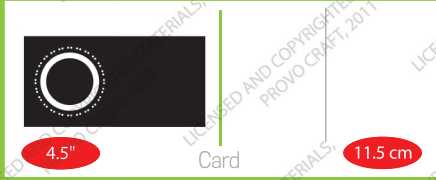
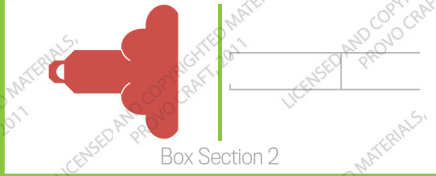
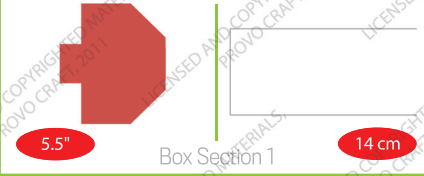
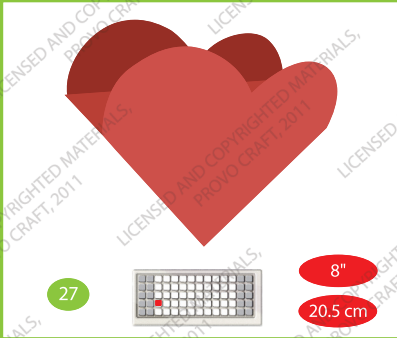

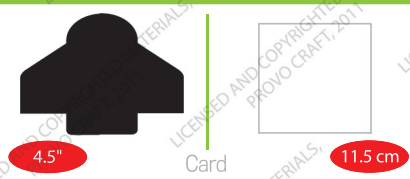
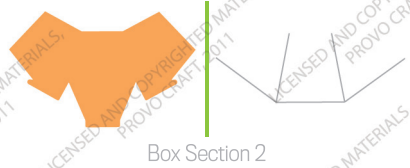
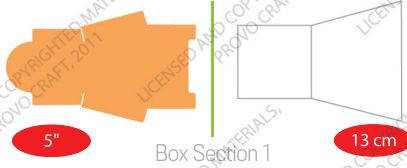
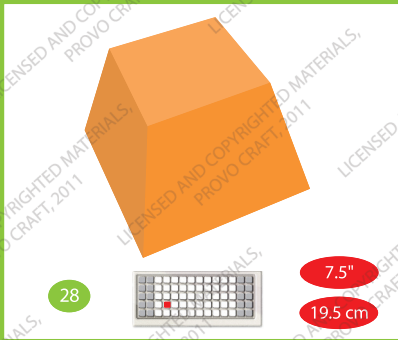

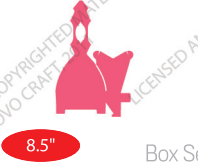

Box Section 1

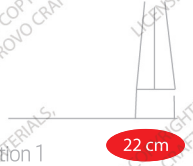

Box Section 2



Tag



Card

13 cm



<BrideBox>



<BrideBox-s>

**Blushing
Bride?**

Phrase



**Blushing
Bride?**

Phrase Shadow/Card Phrase

*Blushing
Bride?*

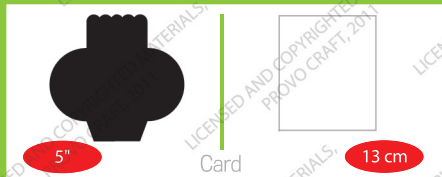
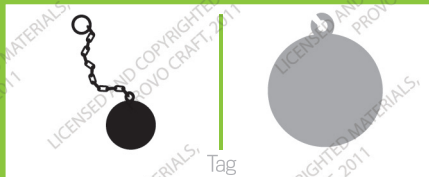
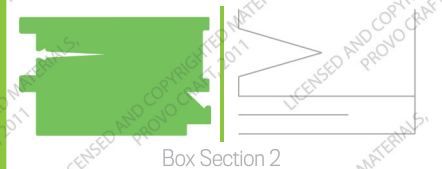
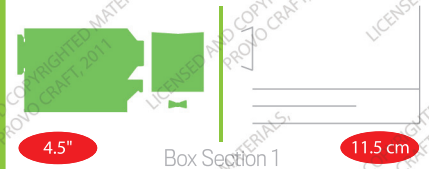



31



8.5"

22 cm



8.5"

Box Section 1



22 cm



Box Section 2



Tag



5"

Card

13 cm



<PlcStgBx>



<PlcStg-s>



Phrase



Phrase Shadow/Card Phrase



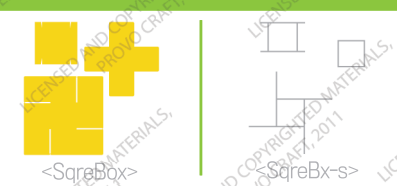
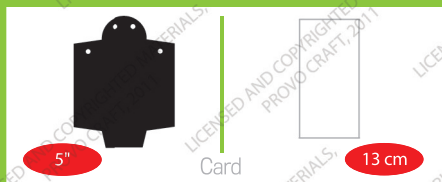
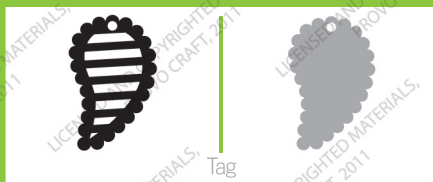
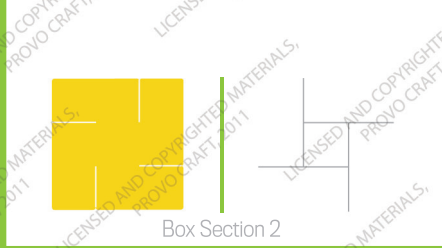
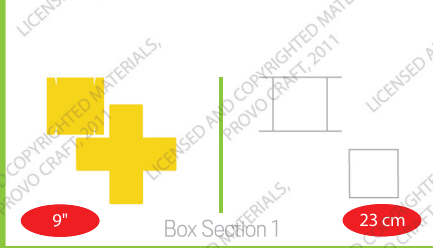
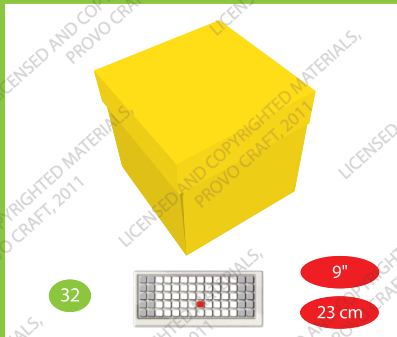

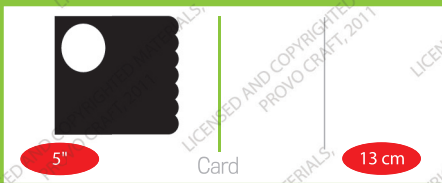
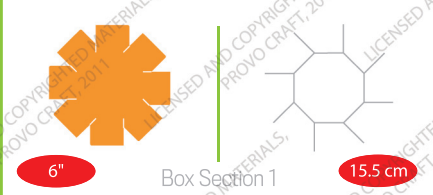
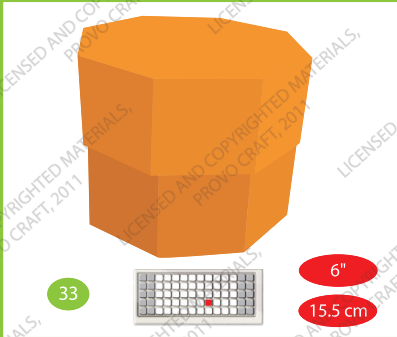

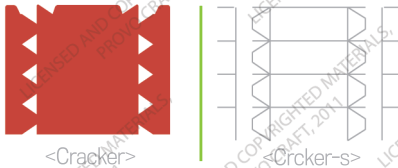
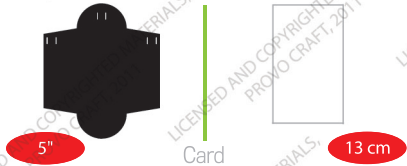
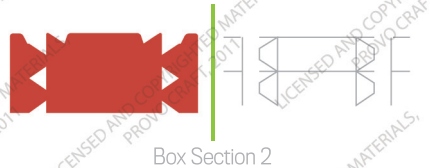
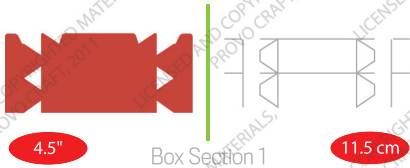
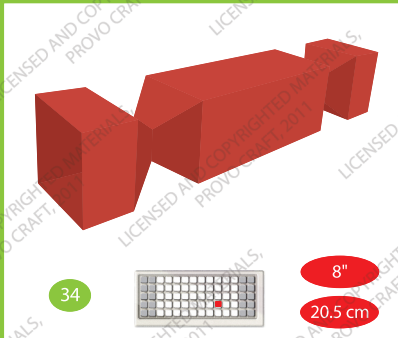



6"

Box Section 1



15.5 cm



Box Section 2



Tag



3"

Card



8 cm



<RndChst>



<RdChst-s>

Welcome
to The
Neighborhood

Phrase

Welcome
to The
Neighborhood

Phrase Shadow/Card Phrase

Welcome
to The
Neighborhood

Welcome to The
Neighborhood

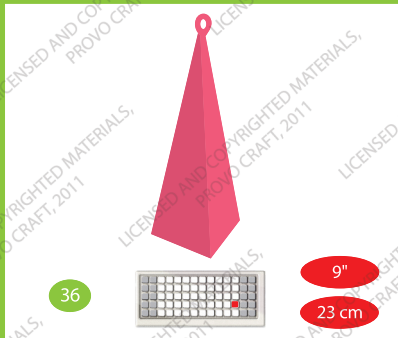

9"
23 cm

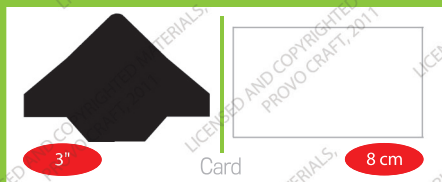
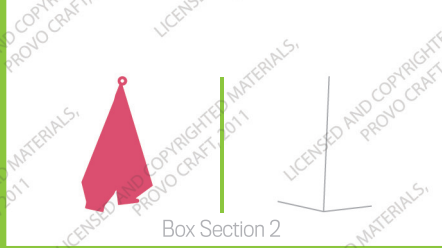
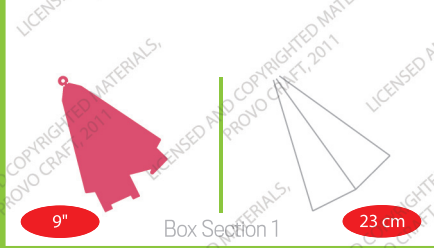

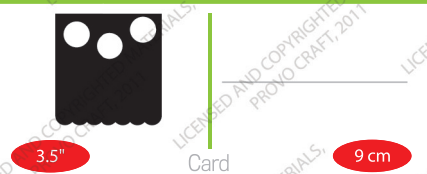
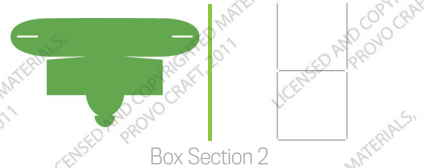
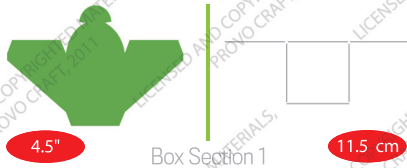
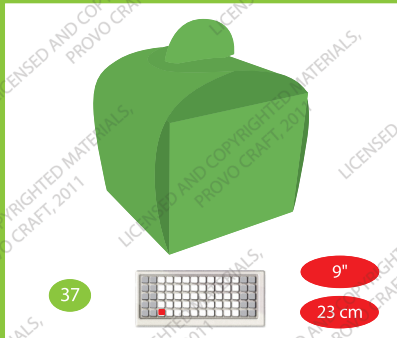

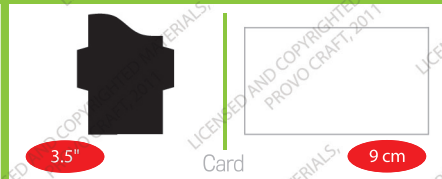
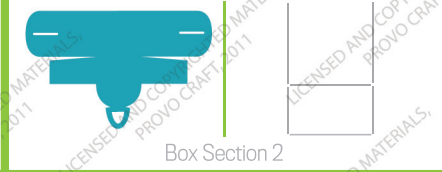
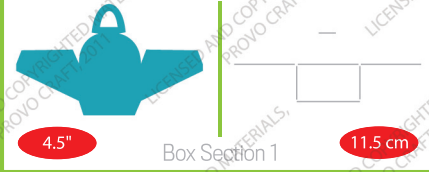

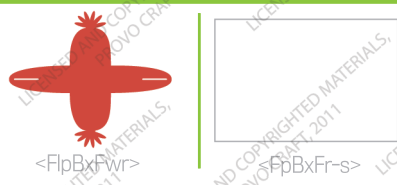
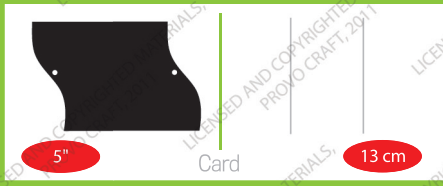
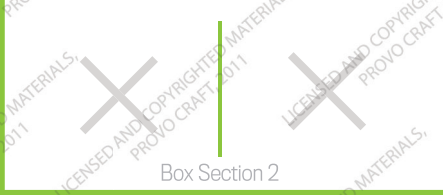
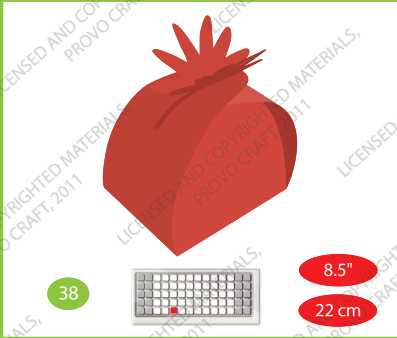

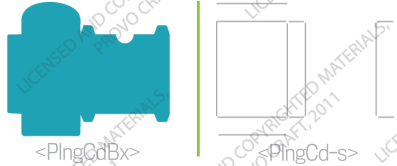
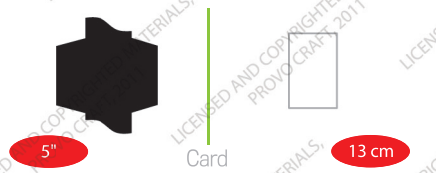
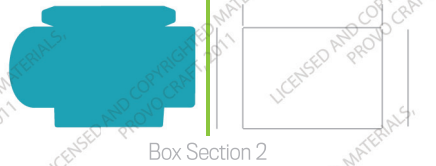
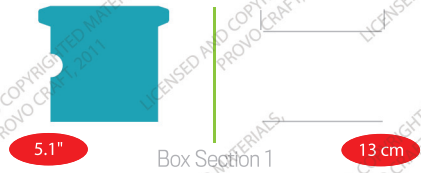

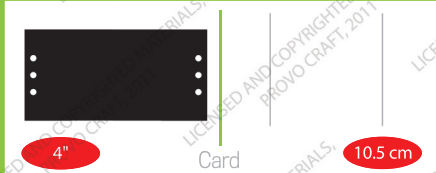
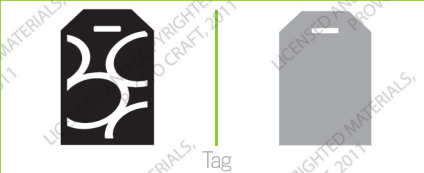
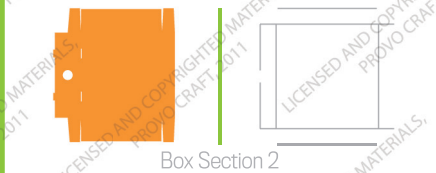
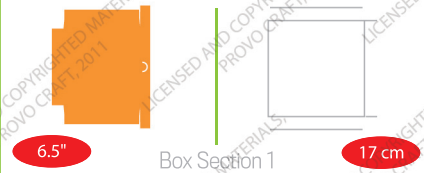

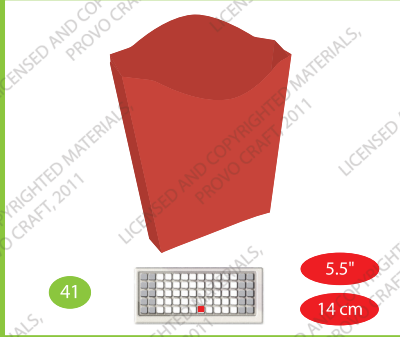

Box Section 1



14 cm



Box Section 2



10.5 cm



Tag



Card



10.5 cm



<FryBox>



<FryBox-s>



Phrase



Phrase Shadow/Card Phrase



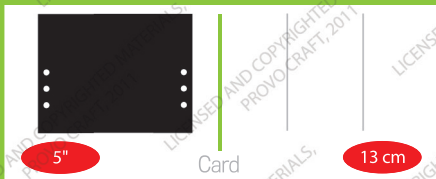
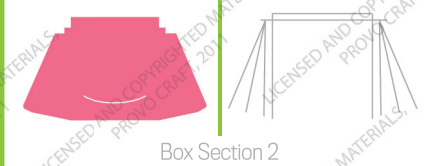
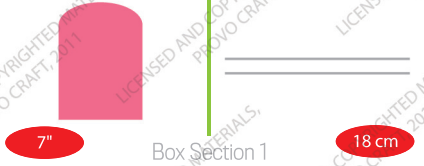

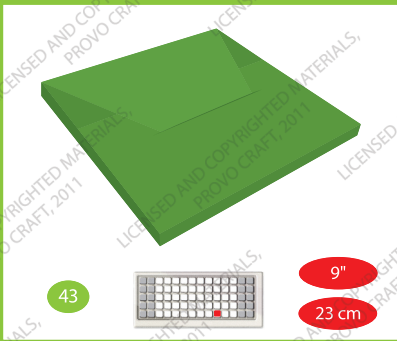

Box Section 1

Box Section 2



Tag



Card



13 cm



<CDGfBx2>



<CDGBx2-s>



Phrase



Phrase Shadow/Card Phrase



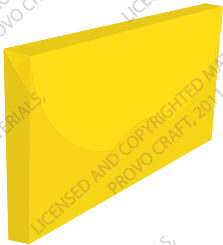

44



4.1"
10.5 cm



4.1"

Box Section 1



10.5 cm



Box Section 2



Tag



5"

Card

13 cm



<BnsCdFdr>

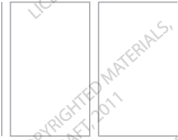

<BnsCdF-s>



Phrase



Phrase Shadow/Card Phrase



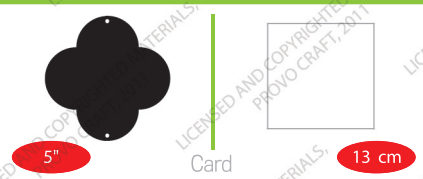
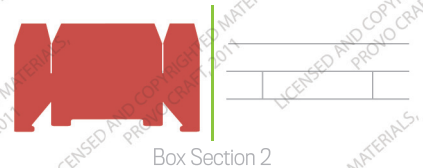
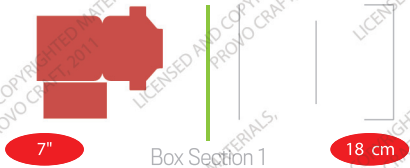

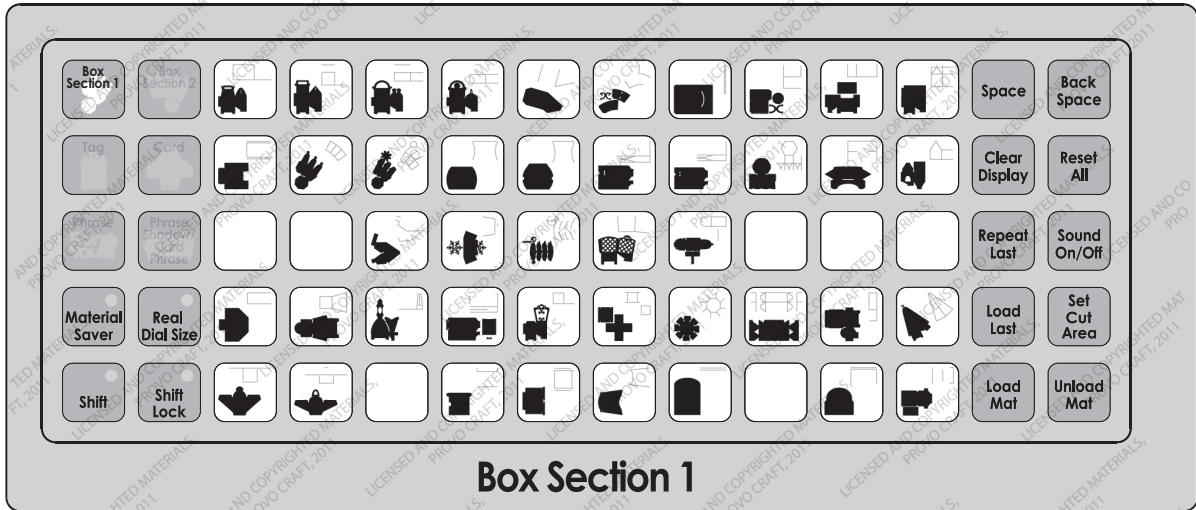

Box Section 1

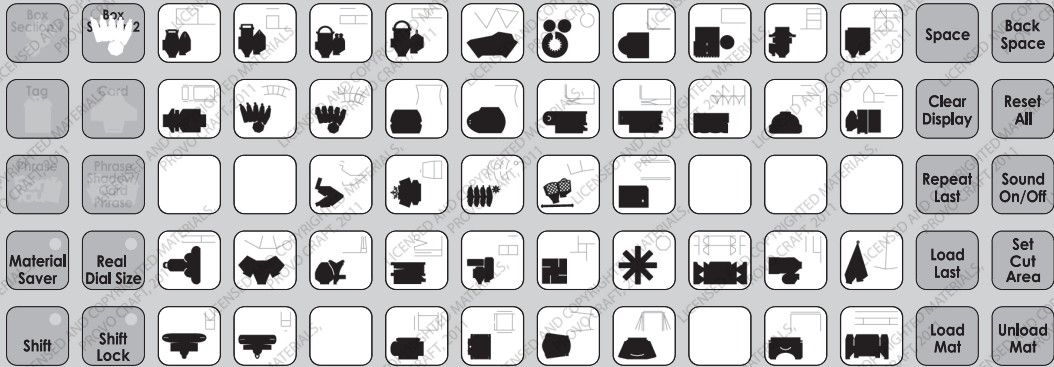

Box Section 2

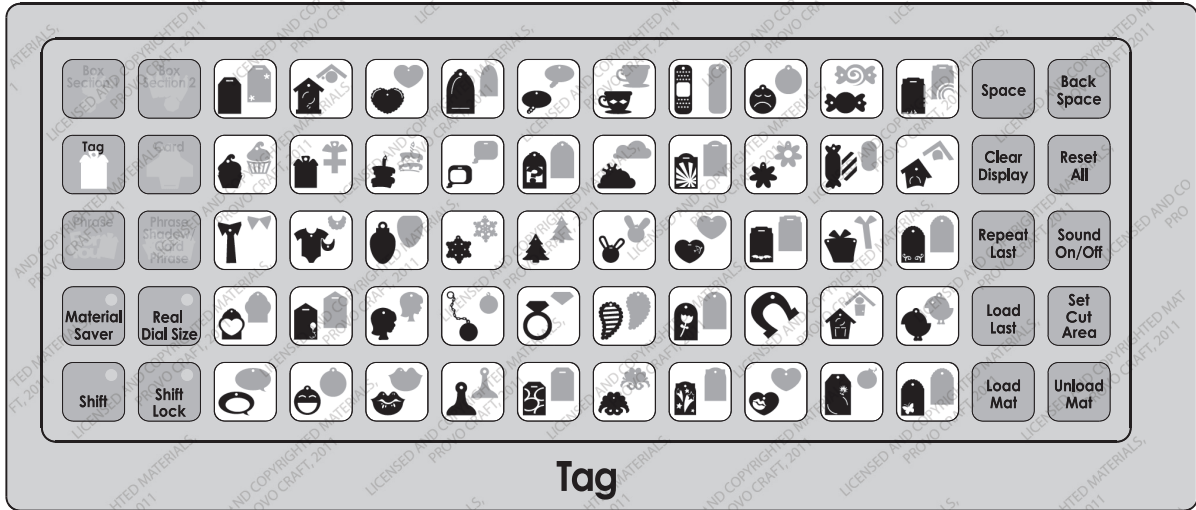

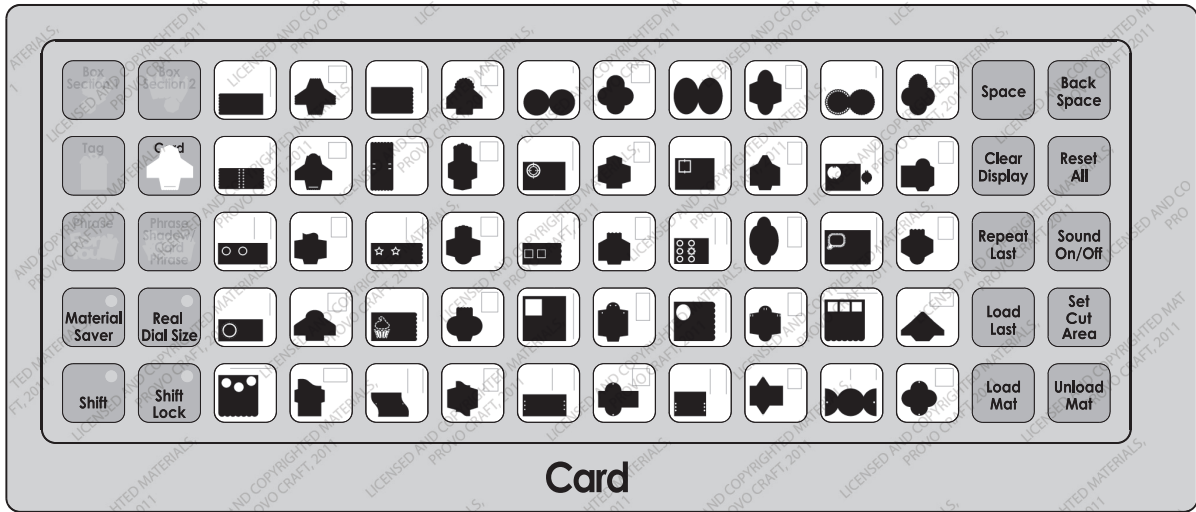



Phrase

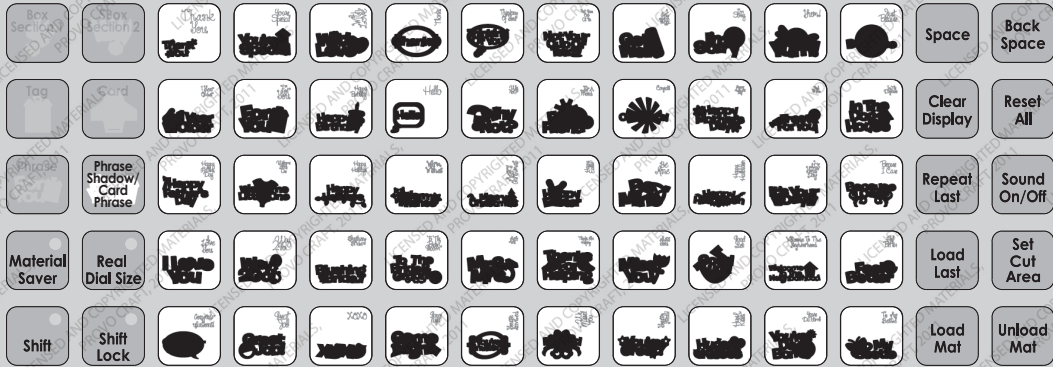

Phrase Shadow/Card Phrase



For in-depth information about using your Cricut® cutting system refer to the User Manual included with your Cricut® machine. If you don't find the answers you need, support is available in the following two ways:

You will find the most current help and documentation on the web site. Find answers to FAQs and Troubleshooting problems any time of the day.

INTERNET: www.cricut.com

Refer to the Customer Support information that came with your Cricut® machine(s) or call for Customer Support options at:

PHONE: 1-877-7CRICUT (727-4288) Monday-Friday 7:00 a.m.-6:00 p.m., Mountain Time



Pour une information plus exhaustive sur comment utiliser le système de découpage Cricut® veuillez vous référer au Manuel de l'Utilisateur inclus avec votre machine Cricut®. Au cas où vous ne trouverez pas de réponse à vos questions, vous trouverez l'appui nécessaire à travers la manière suivante :

Vous trouverez l'aide et la documentation la plus mise à jour dans l'emplacement Web. Trouvez les réponses dans des Questions Fréquentes et dans Détection et Solution de Problèmes à tout moment du jour.

INTERNET: www.cricut.com



Para una información más exhaustiva acerca de cómo usar el sistema de corte Cricut® le rogamos referirse al Manual del Usuario incluido con su máquina Cricut®. En el caso de que no encontrara respuesta a sus preguntas, encontrará el apoyo necesario a través de la forma siguiente:

Encontrará la ayuda y documentación más actualizada en el sitio Web. Encuentre las respuestas en Preguntas Frecuentes y en Detección y Solución de Problemas en cualquier momento del día.

INTERNET: www.cricut.com



Ausführlichere Information über die Benutzung Ihrer persönlichen Cricut® Schneidesystems finden Sie im Benutzerhandbuch, das mit der Cricut® Maschine mitgeliefert wird. Wenn Sie die von Ihnen benötigten Antworten nicht finden, gibt es eine Unterstützungshilfe, die auf den folgenden Wegen erhältlich ist:

Sie werden die aktuellste Hilfe und Dokumentation auf der Webseite finden. Finden Sie Antworten auf häufig gestellte Fragen und zu Fehlerbehebungsproblemen zu jeder Tageszeit.

INTERNET: www.cricut.com



© 2011 Provo Craft and Novelty, Inc.

All rights reserved/Tous droits réservés/Todos los derechos reservados

South Jordan, UT 84095

Made in China/Fabriqué en Chine/Fabricado en China

www.provocraft.com · 7424

